

M12 male 0° / RJ45 male 0° shielded Ethernet

TPE 2x2x24AWG SF/UTP CAT5e bu UL/CSA, CM 9m

Ethernet CAT5

Further cable lengths on request.

Male straight – male straight

M12 – RJ45, 4-pole

D-coded

shielded

8-pole partly used

USA

without cable sleeves

Cable is approved for 600 V

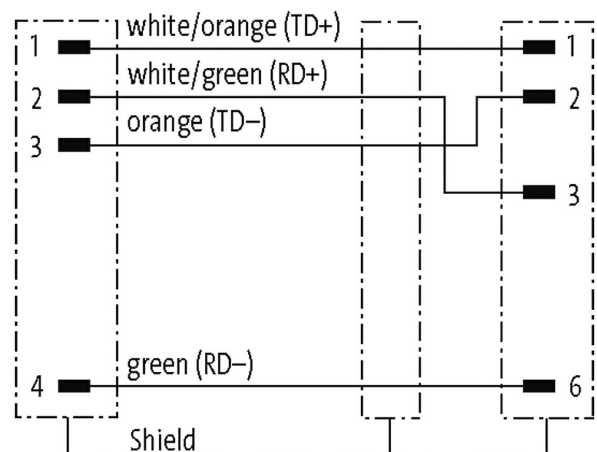
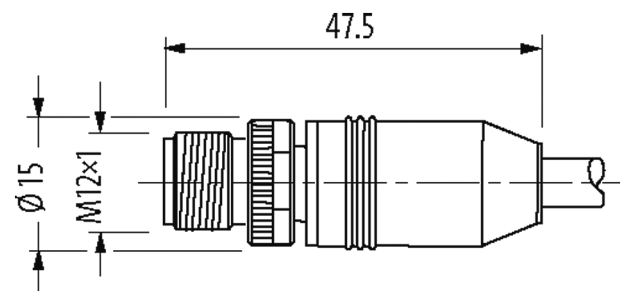
[Link to Product](#)**Illustration**

Product may differ from Image

Approvals

* only for products with UL/CSA approved cable

More Info



EtherNet/IP

Form

Form 44711

General data

Standards	DIN EN 61076-2-101 (M12)
Mounting method	inserted, tightened
Pollution Degree	3
Temperature range	-25...+85 °C, depending on cable quality

Cables

Cable identification	S4U
Cable weight [g/m]	55,66
Material (wire)	Cu wire, tin plated
Construction (core)	7 × 0.203 mm
Diameter (core)	2 × 2 × 0.25 mm ²
AWG	similar to AWG 24
Material (wire isolation)	HDPE
Wire-Ø incl. isolation	1.22 mm ±5%
Color/numbering of wires	(wh-or, or) + (wh-gn, gn)
Shield	yes
	min. 75%
Material (jacket)	TPE
Outer-Ø (jacket)	6.6 mm ±5%
Nominal voltage	1500 V AC
Temperature range (fixed)	-40...+80 °C
Temperature range (mobile)	-40...+80 °C
Bend radius (moving)	10 × outer Ø
No. of bending cycles (C-track)	max. 1 Mio. (25 °C)
Traversing distance (C-track)	max. 0.6 m
Travel speed (C-track)	max. 1.2 m/s
Acceleration (C-track)	max. 2.4 m/s ²
Torsion stress	max. 3 Mio. (25 °C)
No. of torsion cycles	max. 3 Mio. (25 °C)
Torsion speed	60 cycles/min
No./diameter of wires	2 × 2 × 0.25 mm ²
Wire isolation	HDPE (whor, or, whgn, gn)
C-track properties	1 Mio.
Material (jacket)	TPE (UL/CSA)
Jacket Color	blue
Outer Ø	6.6 mm ±5%
Bend radius (moving)	10 × outer Ø
Temperature range (fixed)	-40...+80 °C
Temperature range (mobile)	-40...+80 °C

Technical Data

Operating voltage max. 60 V DC

Operating voltage (only UL listed)	max. 30 V DC
Rated surge voltage	1.0 kV
Operating current per contact	max. 1.5 A (20 °C)
Material group	IEC 60664-1, category I
No. of poles	4
Transfer parameters	CAT5, Class D (ISO/IEC 11801:2002), (EN 50173-1)
Transfer rate	up to 100 Mbit/s full duplex
Coding	M12, D-coded
LED display	no
Locking of ports	Screw thread (M12×1 mm) recommended torque 0.6 Nm, self-securing
Compression gland	M12 (SW13)
Protection	IP67 (M12) - IP20 (RJ45)
Locking material	Zinc die casting, matte nickel plated (M12)
Material	PUR
suitable for corrugated tube (internal Ø)	without

Commercial data

country of origin	DE
customs tariff number	85444210
EAN	4048879675079
eClass	27061801
Packaging unit	1

Sketch

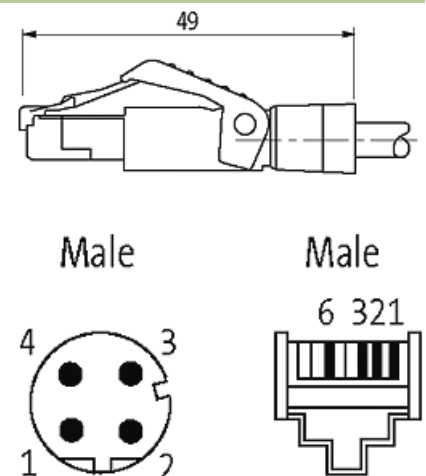

Product may differ from Image